



FORTRESS® BALLOT BOX

FORTRESS®
F-103 BALLOT BOX



FORTRESS®
F-103 BALLOT BOX



STORAGE

When crossed stacked as shown, your ballot boxes are easy and safely stored.

THIS WAY UP – OPEN FROM HERE

COMPONENTS IN BOX

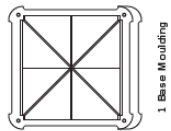

1 Base Moulding

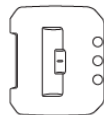

1 Lid Moulding



4 Twin Wall PP



4 Washers &
4 Lock Nuts

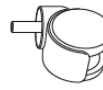

4 Corner Caps

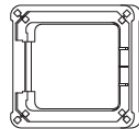

1 Rim Moulding



4 Fixing Pins

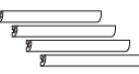

4 Extruded Aluminium
Corner Posts



4 Four Corner Caps

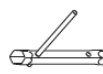

1 box Spanner & T-Bar

* For trays 800 only

ASSEMBLY INSTRUCTIONS

1 Insert the fixing pins into the base moulding until the retaining nut of the pin fits into the corresponding slot.

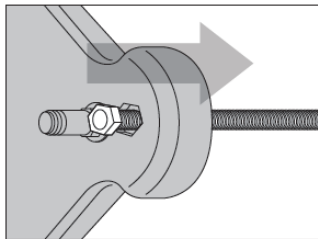

2 Slide a corner post over each pin ensuring they sit correctly within the moulded base.

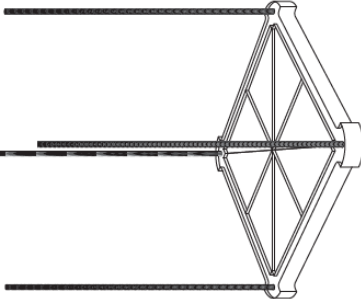

3 Slide the twin wall panels between each post using the recessed number of each post.

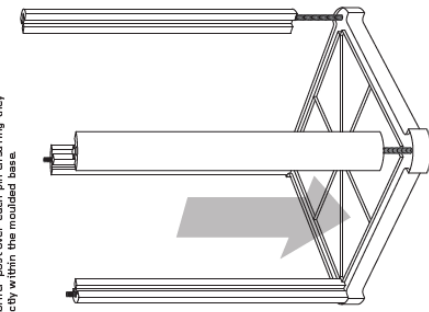

4 Fit the rim moulding to the top of the posts.

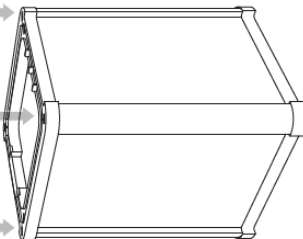

5 Ensure the pins protrude through the fixing holes of the rim. Using a washer and fixing nut, secure the pin. A box spanner and T-bar are provided so the fixing nut can be tightened fully. Do this for all four corners.

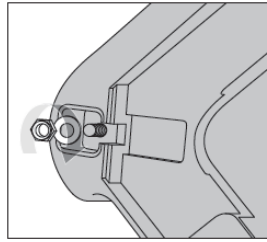

6 Insert the corner caps to cover the finishing nut and pin on each corner.

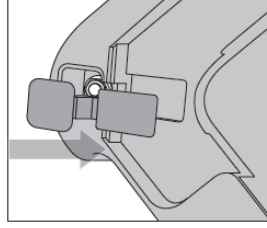

7 Fit the lid moulding onto the rim to finish the assembly.

